



# Product Specifications

<b>Customer</b>	
<b>Model</b>	<b>NTM156 V002</b>



Records of Revision			
Vision	Modifying	Old Description	New Description
v1709.1	Preliminary Specifications		
<b>v1709.2</b>	<b>Format Updated</b>		



## Features

- ★ 15.6 inch, 16:9/1366x768 (HD) Resolution
- ★ Resistive/Capacitive Touch Options
- ★ Metal Cabinet with Diverse Combine Options
- ★ Made in Taiwan, 3 Years Warranty
- ★ Designed for Harsh Environments
- ★ Optional High Brightness/Sunlight Readable
- ★ Optional AG/AR/AF Film
- ★ Optional 9~36VDC Power Input
- ★ Optional Video Input (VGA/DVI/HDMI/DP)
- ★ Optional Software Remote Control by RS232



Side Brackets



Desktop Stand



Wall Mounting



PSE



BSMI



FCC



CE



RoHS



ISO9001



## Display Specifications

Model Name	NTM156X0XXXXX-002 *	Display Mode	Normally White
Screen Diagonal	15.6 inch	Response Time	10 msec.
Display Area	344.2x193.5 mm	Backlight Unit	LED (white LED)
Resolution	1366x768 (HD)	Viewing Angle (L/R, U/D)	160°/160° (CR≥10)
Contrast Ratio	500:1	Backlight Lifetime	50000 HRS
Display Ratio	16:9	Operating Temp.	0~60°C
Support Color	16.7M Colors	Storage Temp.	-20~60°C
Pixel Pitch	0.252x0.252 mm	Surface Treatment	Anti-glare, 3H

\* Depends on options.

## Audio System

	Description	Connector
Audio Input	Stereo	TRS Connector Φ3.5mm (Earphone Jack)
Speakers	2W x2	

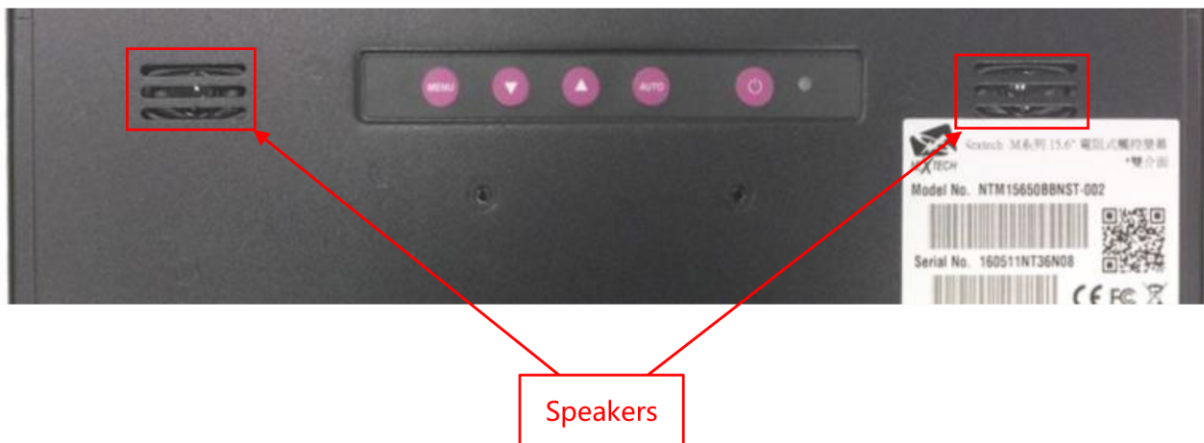

## Accessories

Item	Description	Quantity
VGA Cable	D-Sub 15Pin Male to Male, 1.2 Meter	1
Audio cable	3.5mm Headset Jack, Male to Male, 1.2 Meter	1
AC-DC Adapter	4.16A/12V with CE/FCC/CCC/UL/RoHS/PSE/JET Certification	1
Power cord	*Country Specific	1
USB Cable	A type, Male to Male, 1.5 Meter *(only for touch monitor)	1



## General Options

Brightness			
	Brightness	Environment	Model Name
<b>Standard</b>	<b>300nits</b>	<b>General (Indoor Environment)</b>	<b>NTM156X0XXNXX-002</b>
Option 1	1000nits	Outdoor Environment	NTM156X0XXAXX-002
Option 2	1500nits	Sunlight Readable	NTM156X0XXFXX-002

Video Input		
	Connectors	Model Name
<b>Standard</b>	<b>VGA+DVI</b>	<b>NTM156X0XXXX1-002</b>
Option 1	VGA+HDMI	NTM156X0XXXX2-002
Option 2	VGA+HDMI+DP	NTM156X0XXXX3-002



Standard / VGA+DVI



Option 1 / VGA+HDMI



Option 2 / VGA+HDMI+DP

Power Input	
	Description
<b>Standard</b>	<b>12VDC , DC Power Jack <math>\Phi</math>2.1mm</b>
Option 1	9~36DC , DC Power Jack $\Phi$ 2.1mm
Option 2	12VDC , DC Lockable Power Jack $\Phi$ 2.1mm



Option 2 / Lockable Power Jack



## General Options

Cabinet		
	Description	Model Name
<b>Standard</b>	<b>Galvanized steel (SECC)</b>	<b>NTM156X0XXXSX-002</b>
Option 1	Stainless Steel	NTM156X0XXXLX-002
Option 2	Aluminum	NTM156X0XXXAX-002

Cooling Fan	
	Description
<b>Standard</b>	<b>Fanless</b>
Option	7 Blades/1.2W/4000r.p.m/Max.10.96CFM/28.3dB

OSD Control		
	Item	Description
<b>Standard</b>	<b>Button</b>	<b>Rear Physical Button</b>
Option	Software Remote Control	Software Remote Control by RS232/Serial Port

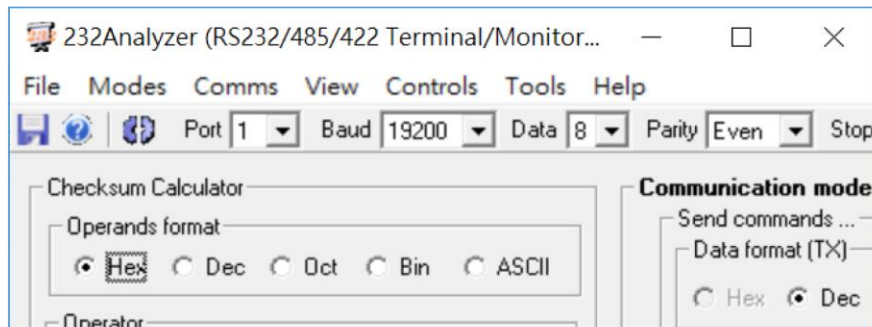

\* Software Remote Control

## Touch Options

Non-Touch			
Model No.	NTM1560XXXXX-002		

Resistive Touch			
Model No.	NTM1565XXXXX-002	Transparency	80%±5%
Touch Screen	5 Wire Resistive Touch	Precision	98.50%
Allowed touch points	1 point	Surface Treatment	Anti-glare <15%
Interface	USB/RS232	Hardness	≥3H

Projected Capacitive Touch			
Model No.	NTM156YXXXXX-002	Transparency	≥90%±3%
Touch Screen	Projected Capacitive	Accuracy	99.00%
Allowed touch points	10 points	Thickness of Cover Lens	1.8±0.1 mm
Interface	USB/RS232 (Optional)	Hardness	≥7H

Active Stylus Option	
Technology	Active Capacitive Coupled
Working Frequencies	90~250 KHZ
Pressure Level	256~1024 Levels
Side Buttons	2 Side Buttons (Eraser, Barrel)
Active Tip Force	5~25g
Max. Tip Force	400g



Surface Film Options	
Standard	(none)
Option	Anti-Glare (AG Film)
Option	Anti-Reflective (AR Film)
Option	Anti-Fouling/Fingerprint (AFP Film)
Option	Anti-Spy (AS Film)
Option	UV-Cut (UV Film)





# Nextech M Series 15.6" Industrial/Touch Display

**NTM156 V002**

## Physical Specifications

Dimension (Max)	<b>369x221x46(±1)mm</b>	Net Weight	<b>≤3.2 KG</b>
VESA Mounting	<b>75x75 mm</b>	Gross Weight	<b>≤5.3 KG</b>

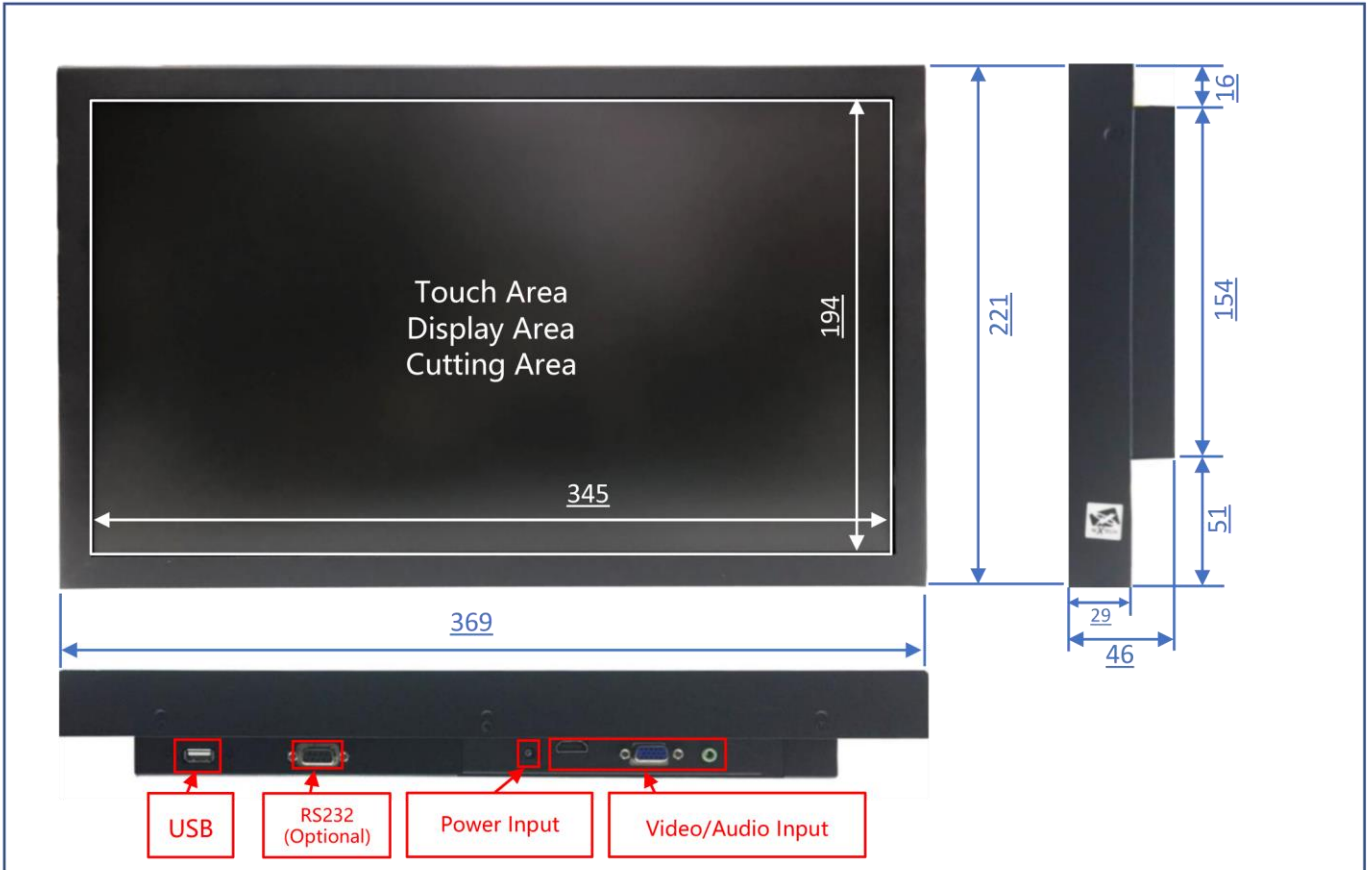



### Optional Accessories (Desktop Stand)

Item	B Stand	Part No.	DST-0B002/DST-1B002
Mounting Pattern	100x100 / 75x75 mm	Dimension (WxHxD)	203x275x227 mm
Material	Steel/Plastic/Aluminum	Net Weight	1.8 KG
Tile (Hinge)	-2° ~ +180°	Support Max. Weight	15 KG

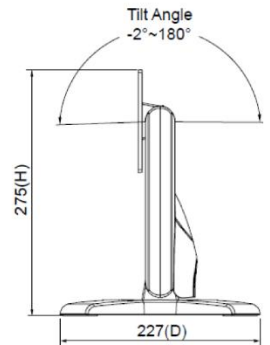
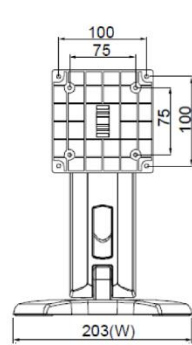

Item	Z Stand	Part No.	DST-0BZ01/DST-1BZ01
Mounting Pattern	100x100 / 75x75 mm	Dimension (WxHxD)	190x240x41.6
Material	SECC	Net Weight	2.6 KG
Tile (Hinge)	±360°	Support Max. Weight	15 KG

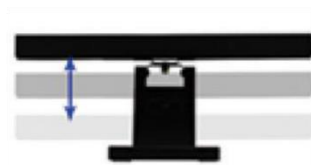
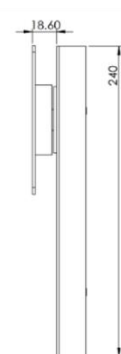
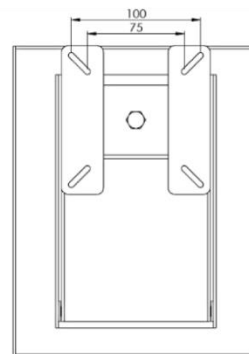



### Optional Accessories (Open-frame Brackets)

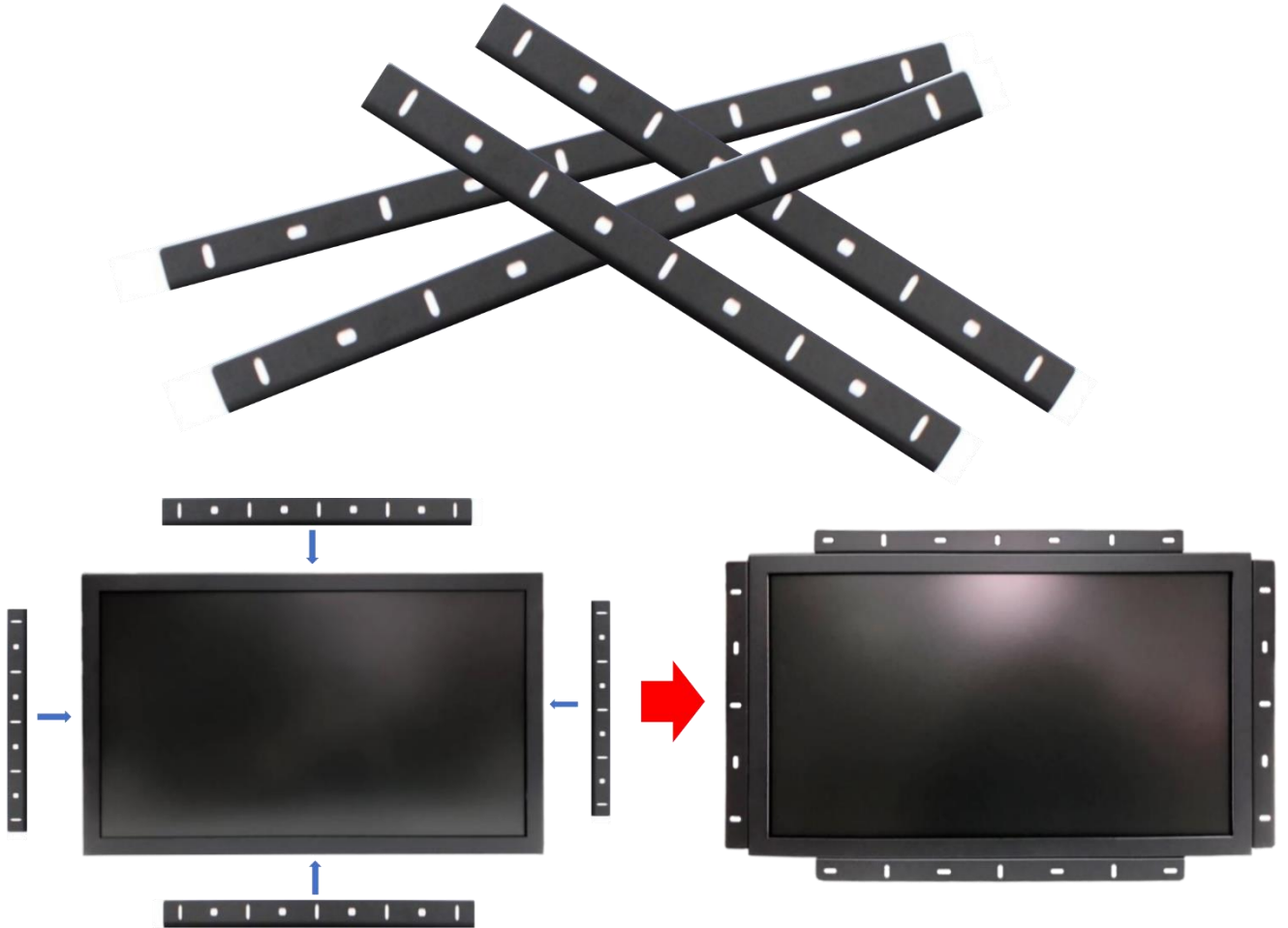

### Optional Accessories (Wall Mount Bracket)

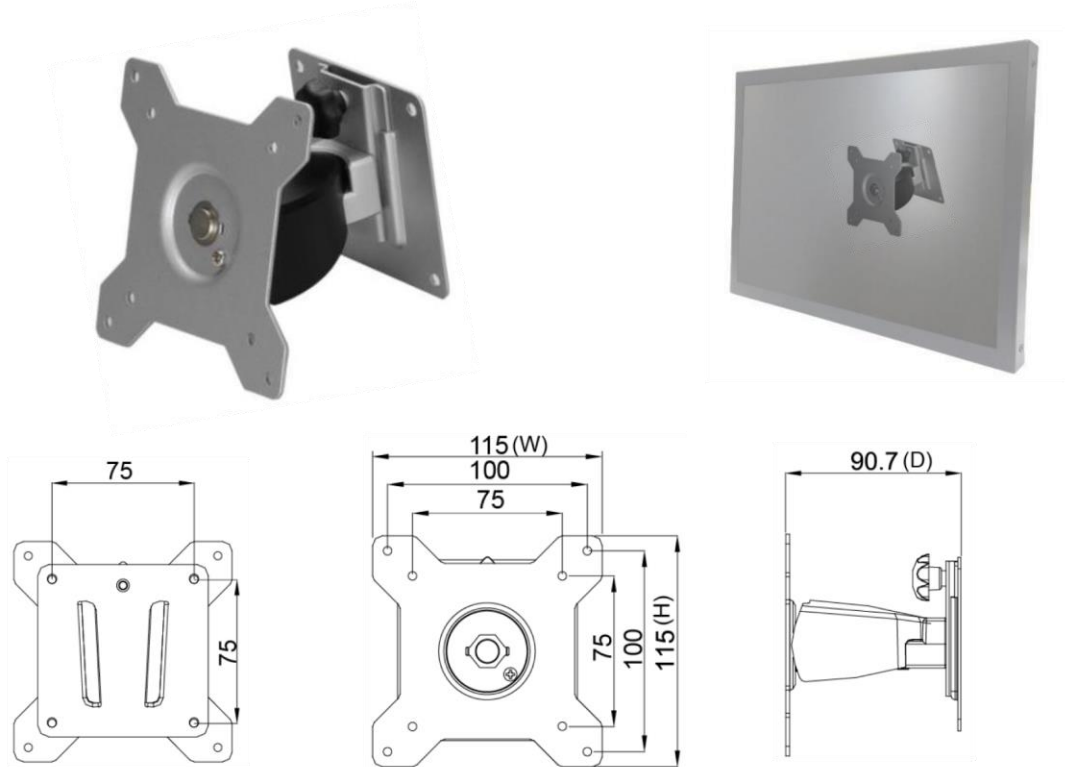

### Packing Information



Dimensions of Carton	<b>500x500x150 mm</b>
Net Weight	<b>3.2 KG</b>
Gross Weight	<b>5.3 KG</b>

## Optional Accessories (Desktop Stand or Arm)



- 273x180x265 mm  
- 1.07 KG  
- Support 12 KG



- 620x556x123 mm  
- 3 KG  
- Support 10 KG



- 250x192x445 mm  
- 1.4 KG  
- Support 12 KG



- 655x858.5x563 mm  
- 7.56 KG  
- Support 30 KG



- 158x403x144 mm  
- 2.12 KG  
- Support 12 KG

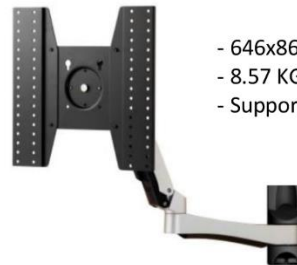

- 646x861x953.5 mm  
- 8.57 KG  
- Support 30 KG



- 423x403x240 mm  
- 1.91 KG  
- Support 12 KG



- 1300x403x307 mm  
- 5.3 KG  
- Support 8 KG (2.7 KG Each)



- 715x393x144 mm  
- 3.68 KG  
- Support 12 KG (6 KG Each)

